

Koliokviumas vyks dviem pogrūpiam, o datą pateiktą paskutinėje paskaitoje 011_007 aš pakeičiu į tokias.
 I-pogrūpis: I-ad., Lapkričio 4 d., 13:30, Xr. 103f.
 II-pogrūpis: IV-ad., Lapkričio 7 d., 13:30, XIr. 506.

Reikės išspręsti 4 uždavinius:
 DH-KAP, MiMA, RSA-Enc, RSA-Sign,
 iš svetainės:

[Cryptography \(imimsociety.net\)](http://imimsociety.net)

Atlikus užduotis Jums reikės žodžiu atsakyti į klausimus susijusius su šiomis užduotimis.

Daugiau info pateiksiu sekančioje paskaitoje, Spalio 23 d.

6027 SAKALAUŠKAS Eligijus							
2024-2025 m.m. rudens semestras							
10 savaitė, Lap 4							
9:00	Pirmadienis Lap 4	Antradienis Lap 5	Trečiadienis Lap 6	Ketvirtadienis Lap 7	Penktadienis Lap 8	Lap 8	Pagrindinis
10:30							
11:00							
12:30							
13:30	P170R111 Kriptologija	X r. 103f. P170M127 Duomenų sauga	Xi r. 506f. P170R111 Kriptologija	Xi r. 103f. P170R111 Kriptologija	Xi r. 506f. P170R111 Kriptologija		
15:00	prof. Eligijus SAKALAUŠKA	prof. Eligijus SAKALAUŠKA	prof. Eligijus SAKALAUŠKA	prof. Eligijus SAKALAUŠKA	prof. Eligijus SAKALAUŠKA		
16:30							
17:00							
17:30		P170M100 Kriptografinės sistemos	Xi r. 103f. P170M100 Kriptografinės sistemos		P170M110 r. 516. Nuolatinis būd Bloky grandinių metodai		
19:00		prof. Eligijus SAKALAUŠKA			prof. Eligijus SAKALAUŠKA		
19:15					P170M110 r. 516. Nuolatinis būd Bloky grandinių metodai		
20:45					prof. Eligijus SAKALAUŠKA		

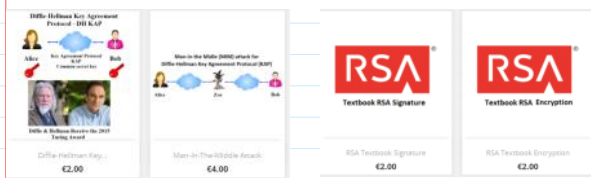

In section: [Intellect \(imimsociety.net\)](http://imimsociety.net)



A **cryptographic hash function** is a special class of [hash function](#) that has certain properties which make it suitable for use in [cryptography](#). It is a mathematical [algorithm](#) that [maps](#) data of arbitrary finite size to a [bit string](#) of a fixed size (a [hash function](#)) which is designed to also be a [one-way function](#), that is, a function which is infeasible to invert.

M - ^{finite length} message
 $h = H(M)$

The only way to recreate the input data from an ideal cryptographic hash function's output is to attempt a [brute-force search](#) of possible inputs to see if they produce a match.

$|h| = 256 \text{ bits}$
 $|h| = 28 \text{ bits}$
 = 7 hex numb.

The input data is often called the *message*, and the output (the *hash value* or *hash*) is often called the *message digest* or simply the *digest*.

From https://en.wikipedia.org/wiki/Cryptographic_hash_function

$0000_b = 0_h \equiv 0_d$
 $0001_b = 1_h \equiv 1_d$
 $0010_b = 2_h \equiv 2_d$
 $1001_b = 9_h \equiv 9_{10}$
 $1010_b = A_h \equiv 10_{10}$
 $1110_b = E_h \equiv 14_{10}$
 $1111_b = F_h \equiv 15_{10}$

Cryptographic hash functions have many [information-security](#) applications, notably in [digital signatures](#), [message authentication codes](#) (HMACs), and other forms of [authentication](#). They can also be used as ordinary [hash functions](#), to index data in [hash tables](#), for [fingerprinting](#), to detect duplicate data or uniquely identify files, and as [checksums](#) to detect accidental data corruption. Indeed, in information-security contexts, cryptographic hash values are sometimes called (*digital*) *fingerprints*, *message digest* or just *hash values*, even though all

these terms stand for more general functions with rather different properties and purposes.

M - message ; $H(M) = h$
 $M \in \{0,1\}^*$; $h \in \{0,1\}^{256}$; $H: \{0,1\}^* \rightarrow \{0,1\}^{256} // \text{SHA256}$

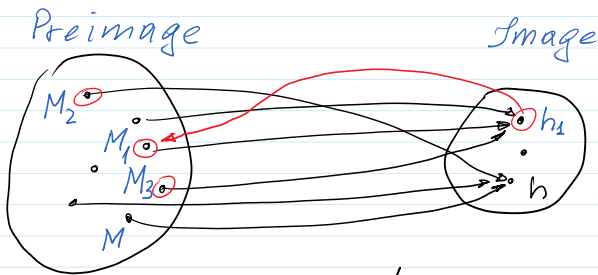

1 GB \rightarrow 256 bits
 many-to-one
 $H(M_1) = H(M_2) = H(M_3) = \dots = h_1$

For given h_1 it is infeasible to find any M_i satisfying:
 $H(M_i) = h_1$

Input	cryptographic hash function	Digest
Fox	cryptographic hash function	DFCD 3454 BBEA 788A 751A 696C 24D9 7009 CA99 2D17
The red fox jumps over the blue dog	cryptographic hash function	0086 46BB FB7D CBE2 823C ACC7 6CD1 90B1 EE6E 3ABC
The red fox jumps ovr the blue dog	cryptographic hash function	8FD8 7558 7851 4F32 D1C6 76B1 79A9 0DA4 AEF E 4819
The red fox jumps oevr the blue dog	cryptographic hash function	FCD3 7FDB 5AF2 C6FF 915F D401 C0A9 7D9A 46AF FB45
The red fox jumps oer the blue dog	cryptographic hash function	8ACA D682 D588 4C75 4BF4 1799 7D88 BCF8 92B9 6A6C

40 Hex numbers = 160 bits

SHA-1
 $\text{SHA-1}: \{0,1\}^* \rightarrow \{0,1\}^{160}$

Avalanche effect

$$2^{160} \xrightarrow[\text{bits.}]{\text{Bintolung}} 2^{80}$$

A cryptographic hash function (specifically [SHA-1](#)) at work. A small change in the input (in the word "over") drastically changes the output (digest). This is the so-called [avalanche effect](#).

Properties

- It is quick to compute the hash value for any given finite message.
- A small change to a message should change the hash value so extensively that the new hash value appears uncorrelated with the old hash value.
- Security properties presented below.

Most cryptographic hash functions are designed to take a [string](#) of any finite length as input and produce a fixed-length hash value.

A cryptographic hash function must be able to withstand all known [types of cryptanalytic attack](#). In theoretical cryptography, the security level of a cryptographic hash function has been defined using the following properties:

- **Pre-image resistance**

Given a hash value h it should be difficult to find any message M such that $h = H(M)$. This concept

is related to that of [one-way function](#). Functions that lack this property are vulnerable to [first preimage attacks](#).

- **Second pre-image resistance**

Given an input M_1 it should be difficult to find (different) input M_2 such that $H(M_1) = H(M_2)$. Functions that lack this property are vulnerable to [second-preimage attacks](#).

- **Collision resistance**

It should be difficult to find **any** two different messages M_1 and M_2 such that $H(M_1) = H(M_2)$. Such a pair is called a cryptographic [hash collision](#). This property is sometimes referred to as *strong collision resistance*. It requires a hash value at least twice as long as that required for preimage-resistance; otherwise **collisions** may be found by a [birthday attack](#).^[2]

These properties form a hierarchy, in that collision resistance implies second pre-image resistance, which in turns implies pre-image resistance, while the converse is not true in general.^[3]

The weaker assumption is always preferred in theoretical cryptography, but in practice, a hash-functions which is only second pre-image resistant is considered insecure and is therefore not recommended for real applications.

Informally, these properties mean that a [malicious adversary](#) cannot replace or modify the input data without changing its digest.

Thus, if two strings have the same digest, one can be very confident that they are identical.

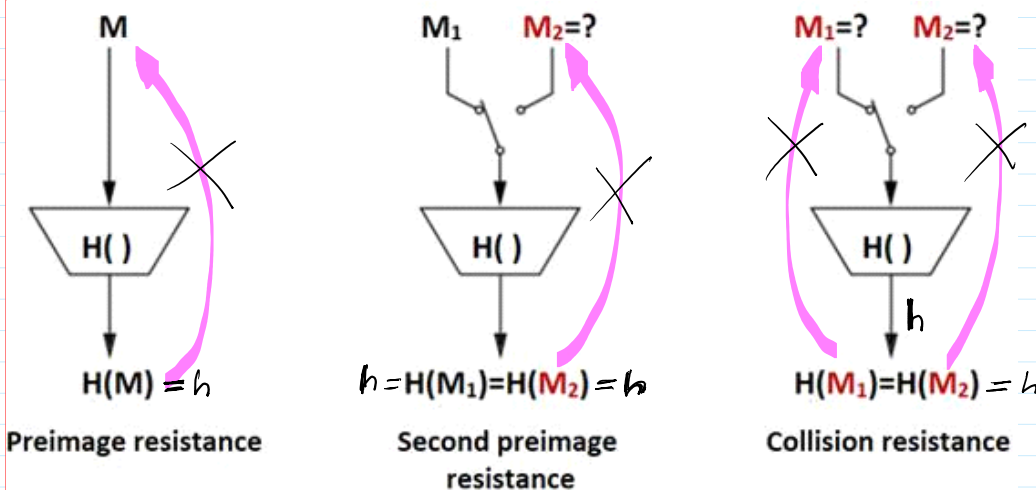

Loan contract

$M_1 = 1000€$ loan.

M_1 - is a valid loan contract.

$h = H(M_1)$; $|h| = 256$ bits

$A: PrK_A = x \rightarrow \text{Sign}(PrK_A, h) = \sigma_h = (r_A, s_A)$

$M_1, \sigma_h, PrK_A \rightarrow$

I_o : finds second preimage M_2 to create loan contract for 100000€ such that $H(M_1) = H(M_2) = h$

Then the valid signature on M_1 is valid also on M_2 .

Then the valid signature on M_1 is valid also on M_2 .

A: $h = H(M_2)$ ← M_2, G_h claim to Alice to pay
 Verif (G_h, h, PrK_A) = True 100 000 € (instead of 1000€)

hd28.m - computing 28 bit length h-value in decimal form
 h28.m - computing 28 bit length h-value in hexadecimal form
 sha256.m - computing 256 bit length h-value in hexadecimal form

Illustration

nonce = 737327631

```
>> sha256('RootHash PrevHash 737327631')
ans = F4AE534CD226FAF799 8C8424B348E020BA80639A687E93A0B8C5130ED C51E6DE
                                     h28('...')
                                     C51E6DE

>> sha256('RootHash PrevHash 737327632')
ans = B856211DF2EE15E30AB770C1A43CE014ECFE573182AFD885B28D96854DBC5F21

>> sha256('RootHash PrevHash 737327633')
ans = 9C18C764E347A58E57AC3F7A3C2874D5889A0E802699FEA47EEFF8C03BFEDA69
```

$O_h \equiv 0000_2$; $F_h \equiv 1111_2$

$h28('...')$ → 7 hex numb.
 $hd28('...')$ → decimal num.

Commitment

An illustration of the potential use of a cryptographic hash is as follows: Alice poses a tough math problem to Bob and claims she has solved it. Bob would like to try it himself, but would yet like to be sure that Alice is not bluffing.

$P = NP$
 $P \neq NP$

Elementary: Sherlock Holmes and docto Watson

Therefore, Alice writes down her solution, computes its hash and tells Bob the hash value (whilst keeping the solution secret).

Then, when Bob comes up with the solution himself a few days later, Alice can prove that she had the solution earlier by revealing it and having Bob hash it and check that it matches the hash value given to him before. (This is an example of a simple commitment scheme; in actual practice, Alice and Bob will often be computer programs, and the secret would be something less easily spoofed than a claimed puzzle solution).

Verifying the integrity of files or messages

Main article: [File verification](#)

An important application of secure hashes is verification of message integrity.

Determining whether any changes have been made to a message (or a file), for example, can be accomplished by comparing message digests calculated before, and after, transmission (or any other event).

For this reason, most digital signature algorithms only confirm the authenticity of a hashed digest of the message to be "signed". Verifying the authenticity of a hashed digest of the message is considered proof that the message itself is authentic.

$f \neq f'$
 $H(f) \neq H(f')$
 $h \quad h'$
 $Sign(PrK, h) \neq Sign(PrK, h')$

MD5, SHA1, or SHA2 hashes are sometimes posted along with files on websites or forums to allow verification of integrity.^[6] This practice establishes a chain of trust so long as the hashes are posted on a site

authenticated by [HTTPS](#).

Password verification [\[edit\]](#)

Main article: [password hashing](#)

A related application is [password](#) verification (first invented by [Roger Needham](#)).

Storing all user passwords as [cleartext](#) can result in a massive security breach if the password file is compromised. One way to reduce this danger is to only store the hash digest of each password. To authenticate a user, the password presented by the user is hashed and compared with the stored hash. (Note that this approach prevents the original passwords from being retrieved if forgotten or lost, and they have to be replaced with new ones.) **The password is often concatenated with a random, non-secret [salt](#) value** before the hash function is applied. The salt is stored with the password hash. Because users have different salts, it is not feasible to store tables of [precomputed](#) hash values for common passwords. [Key stretching](#) functions, such as [PBKDF2](#), [Bcrypt](#) or [Scrypt](#), typically use repeated invocations of a cryptographic hash to increase the time required to perform [brute force attacks](#) on stored password digests.

In 2013 a long-term [Password Hashing Competition](#) was announced to choose a new, standard algorithm for password hashing.

Proof-of-work

Main article: [Proof-of-work system](#)

A proof-of-work system (or protocol, or function) is an *economic* measure to deter [denial of service](#) attacks and other service abuses such as spam on a network by requiring some work from the service requester, usually meaning processing time by a computer. A key feature of these schemes is their asymmetry: the work must be moderately hard (but feasible) on the requester side but easy to check for the service provider. One popular system — used in [Bitcoin mining](#) and [Hashcash](#) — **uses partial hash inversions to prove that work was done**, as a good-will token to send an e-mail. The sender is required to find a message whose hash value begins with a number of zero bits. The average work that sender needs to perform in order to find a valid message is exponential in the number of zero bits required in the hash value, while the recipient can verify the validity of the message by executing a single hash function. For instance, in Hashcash, a sender is asked to generate a header whose 160 bit SHA-1 hash value has the first 20 bits as zeros. The sender will *on average* have to try 2^{19} times to find a valid header.

$$2^{20} = 1M$$

File or data identifier

A message digest can also serve as a means of reliably identifying a file; several [source code management](#) systems, including [Git](#), [Mercurial](#) and [Monotone](#), use the [sha1sum](#) of various types of content (file content, directory trees, ancestry information, etc.) to uniquely identify them. Hashes are used to identify files on [peer-to-peer filesharing](#) networks.

Pseudorandom generation and key derivation

Hash functions can also be used in the generation of [pseudorandom](#) bits, or to [derive new keys or passwords](#) from a single secure key or password.

As of 2009, the two most commonly used cryptographic hash functions were [MD5](#) and [SHA-1](#). However, a successful attack on MD5 broke [Transport Layer Security](#) in 2008.

In February 2005, an attack on SHA-1 was reported that would find collision in about

In February 2005, an attack on SHA-1 was reported that would find collision in about 2^{69} hashing operations, rather than the 2^{80} expected for a 160-bit hash function. In August 2005, another attack on SHA-1 was reported that would find collisions in 2^{63} operations. Though theoretical weaknesses of SHA-1 exist, [14][15] no collision (or near-collision) has yet been found. Nonetheless, it is often suggested that it may be practical to break within years, and that new applications can avoid these problems by using later members of the SHA family, such as [SHA-2](#).

According to birthday paradox it is not required total scan all 2^{160} variants of message M . It is enough to scan $\sqrt{2^{160}} = 2^{80}$ variants.

SHA-2 (Secure Hash Algorithm 2) is a set of [cryptographic hash functions](#) designed by the United States [National Security Agency](#) (NSA). [3]
From <<https://en.wikipedia.org/wiki/SHA-2>>

SHA-2 includes significant changes from its predecessor, [SHA-1](#).

The SHA-2 family consists of six hash functions with [digests](#) (hash values) that are 224, 256, 384 or 512 bits: h28

SHA-224, SHA-256, SHA-384, SHA-512, SHA-512/224, SHA-512/256.

However, to ensure the long-term robustness of applications that use hash functions, there was a [competition](#) to design a replacement for SHA-2.

On October 2, 2012, Keccak was selected as the winner of the [NIST](#) hash function competition.

A version of this algorithm became a [FIPS](#) standard on August 5, 2015 under the name [SHA-3](#).

HMAC - H Message Authentication Code

Use in building other cryptographic primitives: symmetric e-signature realization

Hash functions can be used to build other cryptographic primitives.

For these other primitives to be cryptographically secure, care must be taken to build them correctly.

[Message authentication codes](#) (MACs) (also called [keyed hash functions](#)) are often built from hash functions. [HMAC](#) is such a MAC.

Information
Authentication
Integrity

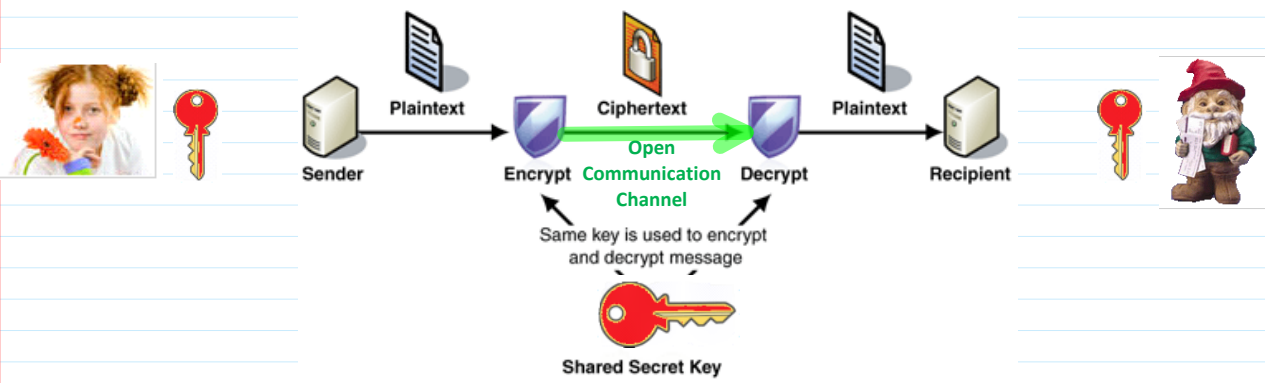

Keyed-hash message authentication code (HMAC) is a specific type of [message authentication code](#) (MAC) involving a [cryptographic hash function](#) (hence the 'H') in combination with a secret [cryptographic key](#). As with any MAC, it may be used to *simultaneously* verify both the [data integrity](#) and the [authentication](#) of

Keyed-hash message authentication code (HMAC) is a specific type of **message authentication code (MAC)** involving a **cryptographic hash function** (hence the 'H') in combination with a secret **cryptographic key**. As with any MAC, it may be used to *simultaneously* verify both the **data integrity** and the **authentication** of a **message**.

Any cryptographic hash function, may be used in the calculation of an HMAC.

The cryptographic strength of the HMAC depends upon the **cryptographic strength** of the underlying hash function, the size of its hash output, and on the size and quality of the key.

HMAC based e-signature

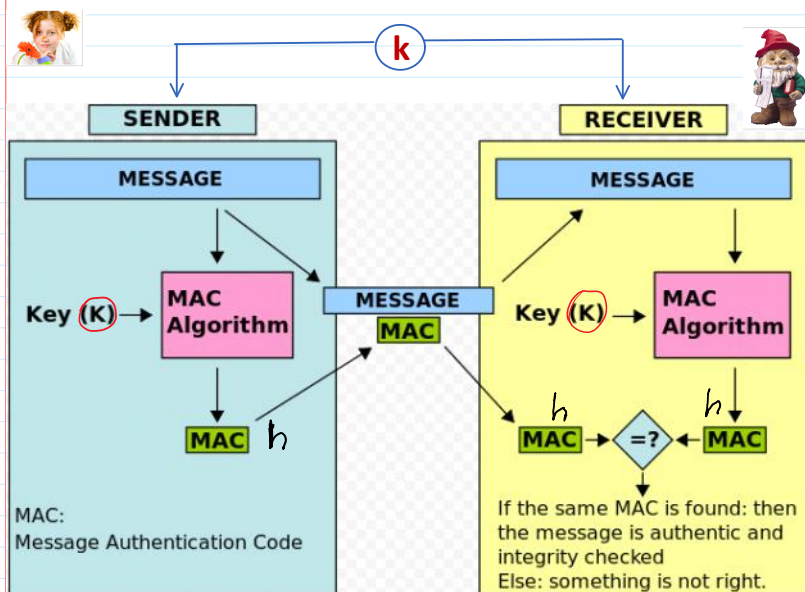

*Authentic
Integral*

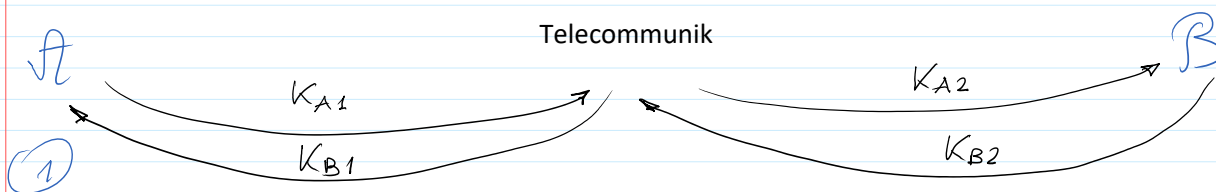

$$K_{AB} = (K_B)^x \text{ mod } p = K = (K_A)^y \text{ mod } p = K_{BA}$$

K_1

K_2

m - message

$$\text{Enc}(K_1, m) = C_1$$

$$\text{Dec}(K_1, C_1) = m$$

Data center

$$\text{Enc}(K_2, m) = C_2$$

$$\text{Dec}(K_2, C_2) = m$$

② Telekommunik software and its updating

Backdoors

```

>> sha256('RootHash PrevHash 737327631')
ans = F4AE534CD226FAF7998C8424B348E020BA80639A687E93A0B8C5130EDC51E6DE
>> h28('RootHash PrevHash 737327631')
ans = C51E6DE
>> hd28('RootHash PrevHash 737327631')
ans = 206694110
>> dec2bin(ans)
ans = 1100010100011110011011011011110
>> dec2hex(206694110)
ans = C51E6DE

```

Till this place

Hash functions based on block ciphers

There are several methods to use a [block cipher](#) to build a cryptographic hash function, specifically a [one-way compression function](#).

The methods resemble the [block cipher modes of operation](#) usually used for encryption.

Many well-known hash functions, including [MD4](#), [MD5](#), [SHA-1](#) and [SHA-2](#) are built from block-cipher-like components

HMAC can be constructed from the block cipher using cipher block chaining (CBC) mode of operation.

AES_k-CBC

M - to be signed.

$$C = \text{AES_CBC}(k, M)$$

↓
256

CBC-MAC

Cipher block chaining message authentication code (CBC-MAC) is a technique for constructing a [message authentication code](#) from a [block cipher](#). The message is encrypted with some block cipher algorithm in [CBC mode](#) to create a chain of blocks such that each block depends on the proper encryption of the previous block.

This interdependence ensures that a change to any of the plaintext bits will cause the final encrypted block to change in a way that cannot be predicted or counteracted without knowing the key to the block cipher.

From <https://en.wikipedia.org/wiki/CBC-MAC>

$$k \mid = 256 \text{ b} \Rightarrow B_i = C_i = 256$$

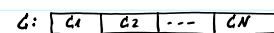
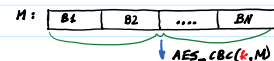

$$h_{MAC} = C_1 \oplus C_2 \oplus \dots \oplus C_N = h$$

bitwise XORing

|h| = 256 b.

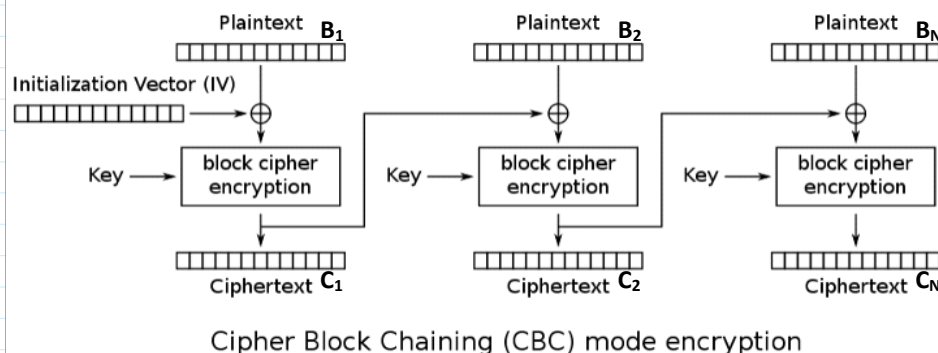

Chosen Plaintext Attack

A:

$$\left. \begin{array}{l} E_{\text{CBC}}(k, m) = c \\ H_{\text{CBC}}(k, c) = h \end{array} \right\} \begin{array}{l} \text{encrypt} \\ \& \\ \text{hash} \end{array} \xrightarrow{c, h}$$

B: 1) $H_{\text{CBC}}(k, c) = h'$

? $h \neq h'$ if ok

2) $D(k, c) = m$